

Optoelectronic level switch

For the process industry

Models OLS-S, OLS-H

WIKA data sheet LM 31.01



Applications

- Chemical, petrochemical, natural gas, offshore industries
- Shipbuilding, machine building, refrigerator units
- Power generating equipment, power plants
- Process and drinking water treatment
- Wastewater and environmental engineering

Special features

- Temperature ranges from -269 ... +400 °C
- Versions for pressure ranges from vacuum to 500 bar
- Special versions: High pressure, interface measurement
- Explosion-protected versions
- Signal processing is made using a separate model OSA-S switching amplifier

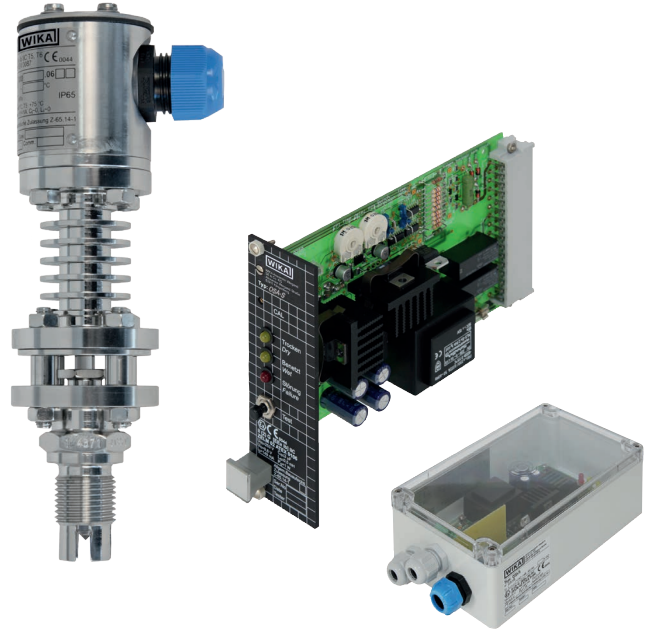

Fig. left: Model OLS-H, high-pressure version

Fig. centre: Model OSA-S, 19" plug-in card

Fig. right: Model OSA-S, polycarbonate add-on case

Description

The model OLS optoelectronic level switch is used for the detection of limit levels in liquids. This is widely independent of physical characteristics such as refractive index, colour, density, dielectric constant and conductivity. Measurement is also done in small volumes.

The switches consist of an infrared LED and a phototransistor. The light of the LED is directed into a prism. So long as the sensor tip of the prism is in the gas phase, the light is reflected within the prism to the receiver. When the liquid in the vessel rises and wets approximately 2/3 of the glass tip, the infrared lightbeam into the liquid is interrupted and only a small portion reaches the receiver. This difference is evaluated by the electronics and triggers a switching operation.

The model OLS optoelectronic level switch is also available as an explosion-protected version (zone 0 and zone 1). Together with the model OSA-S switching amplifier the sensor can be used as overflow control. The instruments are very robust and designed for rough operating conditions.



The cable to the switching amplifier does not need any shield, enabling easy and economic cabling. The model OSA-S switching amplifier is operated with an intrinsically safe signal circuit. For the 19" plug-in card version, all operating elements, except for the switch for changing the alarm direction and the potentiometers for the time delay, can be accessed from the front. If incorporated in an add-on case, a transparent cover allows seeing the switching statuses.

Model overview



Model	Description	Max. pressure in bar		Medium temperature	Ambient temperature
		Standard	High-pressure		
OLS-S, OLS-H	Optoelectronic level switch	250 bar	500 bar	-269 ... +400 °C	-65 ... +95 °C
KSR-OPTO.21*06XX	Optoelectronic level switch, intrinsically safe (Ex i)	250 bar	500 bar	-269 ... +400 °C	-65 ... +95 °C
OSA-S	Switching amplifier for optoelectronic level switches	-		-	-40 ... +60 °C
KSR-OPTO.2502.XX	Switching amplifier, intrinsically safe (Ex i)	-		-	-40 ... +60 °C

Approvals

■ Models OLS-S, OLS-H, OSA-S

Logo	Description	Country
	EU declaration of conformity <ul style="list-style-type: none"> ■ EMC directive ■ Low voltage directive 	European Union
	EAC (option) <ul style="list-style-type: none"> ■ EMC directive ■ Low voltage directive 	Eurasian Economic Community

■ Models KSR-OPTO.21*06XX, KSR-OPTO.2502.XX

Logo	Description	Country
	EU declaration of conformity <ul style="list-style-type: none"> ■ EMC directive ■ Low voltage directive ■ Hazardous areas (option) 	European Union
	KSR-OPTO.21*06XX: Zone 0/1, gas II 1/2G Ex ib IIC T5, T6 ZELM 06 ATEX 0299 KSR-OPTO.2502.XX: Zone 0/1, gas II (2)G [Ex ib] IIC ZELM 06 ATEX 0300	
	EAC (option) <ul style="list-style-type: none"> ■ EMC directive ■ Low voltage directive ■ Hazardous areas 	Eurasian Economic Community

Approvals and certificates, see website

Optoelectronic level switch, standard version Model OLS-S

Model KSR-OPTO.21*06XX: ZELM 06 ATEX 0299 (II 1/2G Ex ib IIC T5, T6)

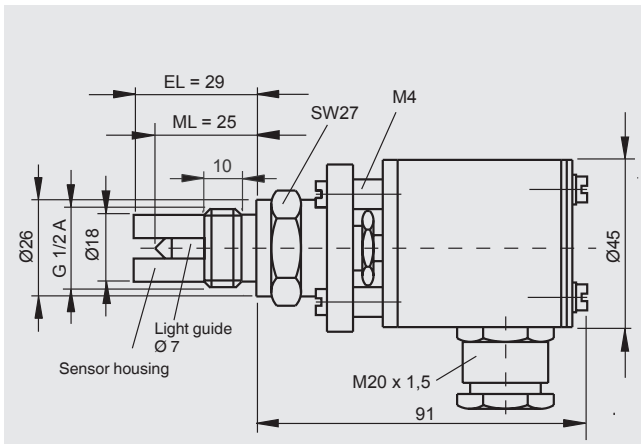

Specifications	
Switch point ML	Standard: 25 mm, with extension 50 ... 960 mm
Insertion length EL	Standard: 29 mm (ML + 4 mm)
Medium temperature	-65 ... +250 °C
Ambient temperature	-65 ... +95 °C
Pressure range	0 ... 250 bar
Measurement type	Level measurement with glass tip shape V, option: Interface layer
Glass protection	Guard finger
Process connection	G 1/2 A, 1/2 NPT, option: Flange
Material	Process connection: stainless steel 1.4571 Case: 1.4301 Option: Hastelloy, other materials on request
Light guide	Clad core glass Option: quartz (ML: max. 200 mm) sapphire (ML: max. 60 mm)
Mounting position	As required
Measuring accuracy	±0.5 mm
Repeat accuracy	±0.1 mm
Light source	IR light 930 nm
Ambient light	Max. 100 Lux
Cable gland	M20 x 1.5; Ex: blue
Terminal connection	3 x 2.5 mm ²
Ingress protection	IP66 per IEC/EN 60529

Optoelectronic level switch, high-pressure version Model OLS-H

Model KSR-OPTO.21*06XX: ZELM 06 ATEX 0299 (II 1/2G Ex ib IIC T5, T6)

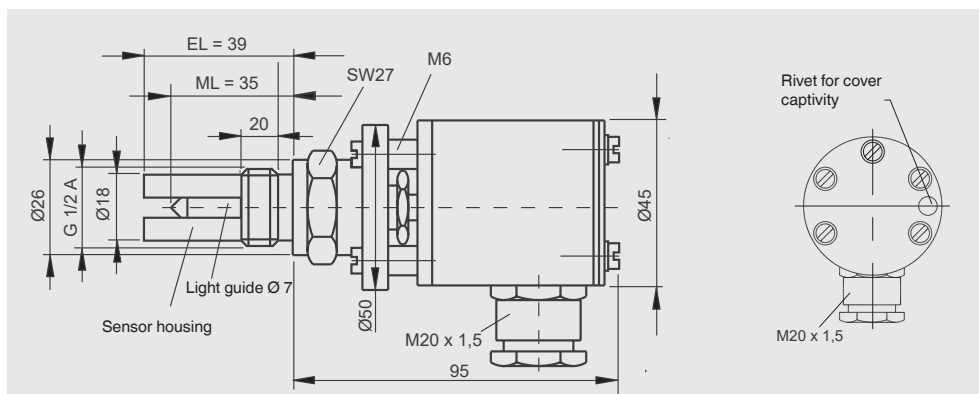

Specifications

Switch point ML	Standard: 35 mm, with extension 60 ... 960 mm
Insertion length EL	Standard: 39 mm (ML + 7 mm)
Medium temperature	-65 ... +250 °C
Ambient temperature	-65 ... +95 °C
Pressure range	0 ... 500 bar
Measurement type	Level measurement with glass tip shape V, option: Interface layer
Glass protection	Guard finger
Process connection	G 1/2 A, 1/2 NPT, option: Flange
Material	Process connection: stainless steel 1.4571 Case: 1.4301 Option: Hastelloy, other materials on request
Light guide	Clad core glass Option: quartz (ML: max. 200 mm) sapphire (ML: max. 60 mm)
Mounting position	As required
Measuring accuracy	±0.5 mm
Repeat accuracy	±0.1 mm
Light source	IR light 930 nm
Ambient light	Max. 100 Lux
Cable gland	M20 x 1.5; Ex: blue
Terminal connection	3 x 2.5 mm ²
Ingress protection	IP66 per IEC/EN 60529

Options for models OLS-S and OLS-H

Cooling fin for high- and low-temperature version

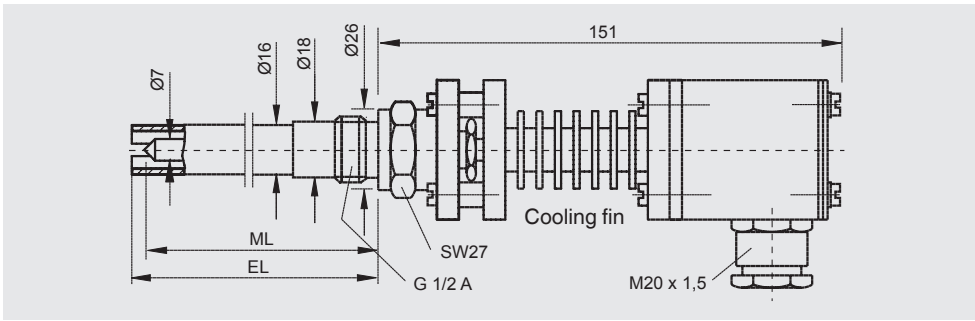

Specifications

Temperature range	-269 ... +400 °C
Ambient temperature	-65 ... +95 °C

Flanged version

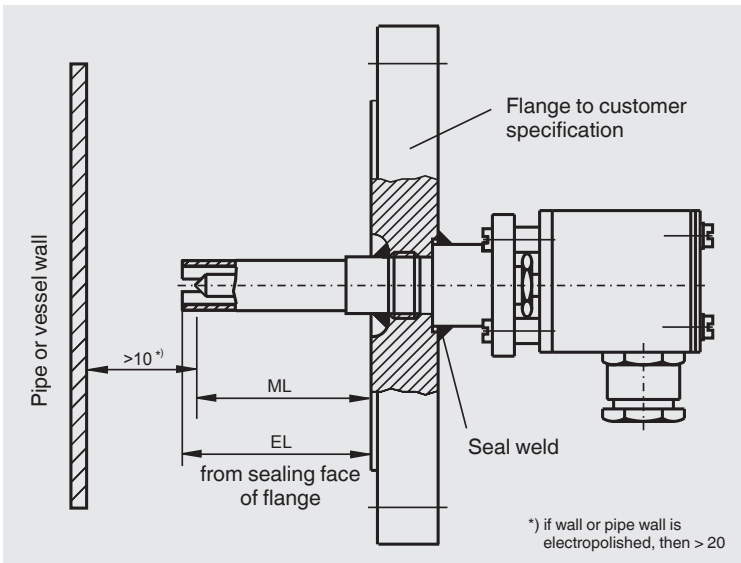

Process connection	Nominal width	Pressure rating	Sealing face
Flange EN 1092-1	DN 20 ... DN 50	PN 16 ... PN 400	B1, B2, C, D, E
Flange DIN	DN 20 ... DN 50	PN 16 ... PN 400	C, F, N
Flange ANSI	1/2" ... 2"	Class 150 ... Class 2500	RF, RTJ, FF

Version with sieve

Protection from gas bubble formation at the glass tip



Version for interface layer

Open glass tip, shape U

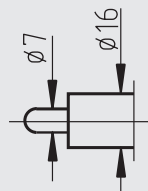

Electrical connection diagram

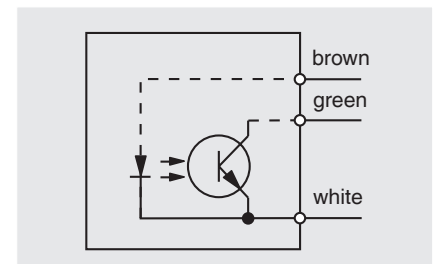

Switching amplifier for optoelectronic level switch Model OSA-S

Model KSR-OPTO.2502.XX: ZELM 06 ATEX 0300 (II (2)G [Ex ib] IIC)

Version 19" plug-in card

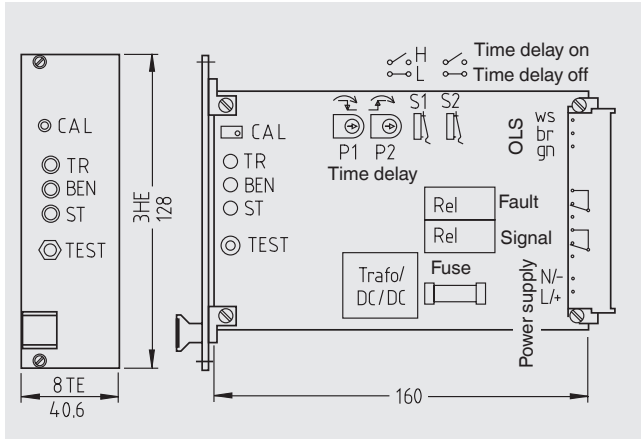

Version in polycarbonate add-on case

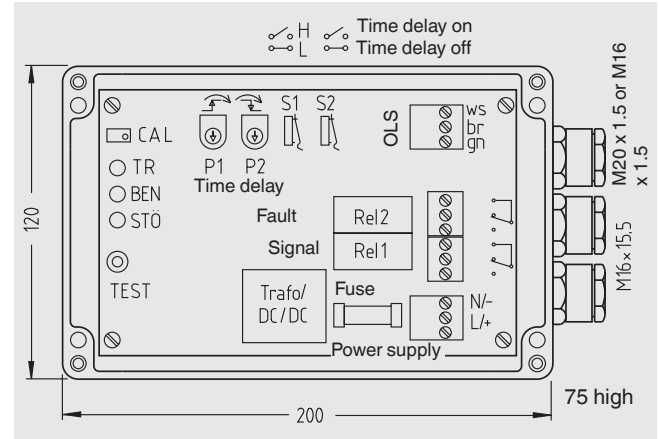

Specifications	
Ambient temperature	-25 ... +60 °C
Power supply	AC 230 V, AC 15/120 V, AC 24 V, DC 24 V
Power consumption	2.8 VA, 3 W
Outputs	Signal relay, change-over contact, 250 V, 3 A, 100 VA Failure relay, change-over contact, 250 V, 3 A, 100 VA
Cable gland	-
Max. connection cross-section	2.5 mm ²
Max. cable length	175 ... 600 m (with 0.5 ... 1.5 mm ²)
Ingress protection	IP20 per IEC/EN 60529

Specifications	
Ambient temperature	-40 ... +40 °C
Power supply	AC 230 V, AC 15/120 V, AC 24 V, DC 24 V
Power consumption	2.8 VA, 3 W
Outputs	Signal relay, change-over contact, 250 V, 3 A, 100 VA Failure relay, change-over contact, 250 V, 3 A, 100 VA
Cable gland	M16 x 1.5 / M20 x 1.5 Ex: blue
Max. connection cross-section	2.5 mm ²
Max. cable length	175 ... 600 m (with 0.5 ... 1.5 mm ²)
Ingress protection	IP65 per IEC/EN 60529

Application information

- 32-pin connector per DIN 41612, form F
- Operating elements accessible from the front
Exceptions:
 - Switch for changing the alarm direction
 - Potentiometers for time delay

Application information

- Transparent cover, good readability of the LED displays for dry/wetted/fault
- Ingress protection IP65 per IEC/EN 60529, field use possible

General data

- Functions
- Alarm direction selectable
 - On-delay and drop-out delay for signal relay settable up to approx. 8 s
- Monitoring
- Wire break signal circuit
 - Short-circuit signal circuit
 - Internal power supply, fail-safe

Design data	
Max. external inductance L_{max}	0.5 mH
Max. external capacitance C_{max}	3 μ F
U_0	\leq 9.6 V
I_0	\leq 149 mA
P_0	\leq 1.0 W

Electrical connection diagram

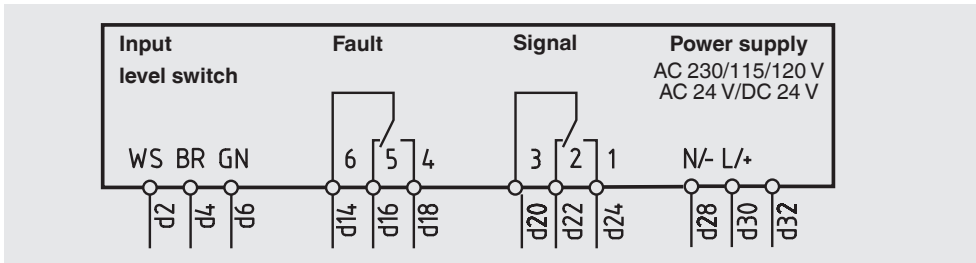

Switching amplifier, model OSA-S

Version	Power supply	Order number
Polycarbonate add-on case	DC 24 V potential-free	500281
	DC 24 V non-potential-free	500283
	AC 24 V	500279
	AC 115/120 V	on request
	AC 230 V	500275
19" plug-in card	DC 24 V potential-free	500282
	DC 24 V non-potential-free	500284
	AC 24 V	500280
	AC 115/120 V	500278
	AC 230 V	500277

Switching amplifier with Ex i approval, model KSR-OPTO.2502.XX

Version	Power supply	Order number
Polycarbonate add-on case	DC 24 V with potential isolation	500291
	AC 24 V	500289
	AC 115/120 V	500287
	AC 230 V	500285
19" plug-in card	DC 24 V with potential isolation	500292
	AC 24 V	500290
	AC 115/120 V	500288
	AC 230 V	500286

Ordering information

To order the described product the order number is sufficient.

Alternatively:

Level switches: Model / Process connection / Measurement type / Switch point ML / Process specifications (operating temperature and pressure) / Material / Glass / Sieve

Switching amplifiers: Model / Case / Power supply

© 01/2010 WIKA Alexander Wiegand SE & Co. KG, all rights reserved.
The specifications given in this document represent the state of engineering at the time of publishing.
We reserve the right to make modifications to the specifications and materials.

